

Utjecajne funkcije i utjecajne linije

Trozglobni sistemi

(Kinematički postupak)

Trozglobni okvir

UL za vertikalnu reakciju u desnome ležaju

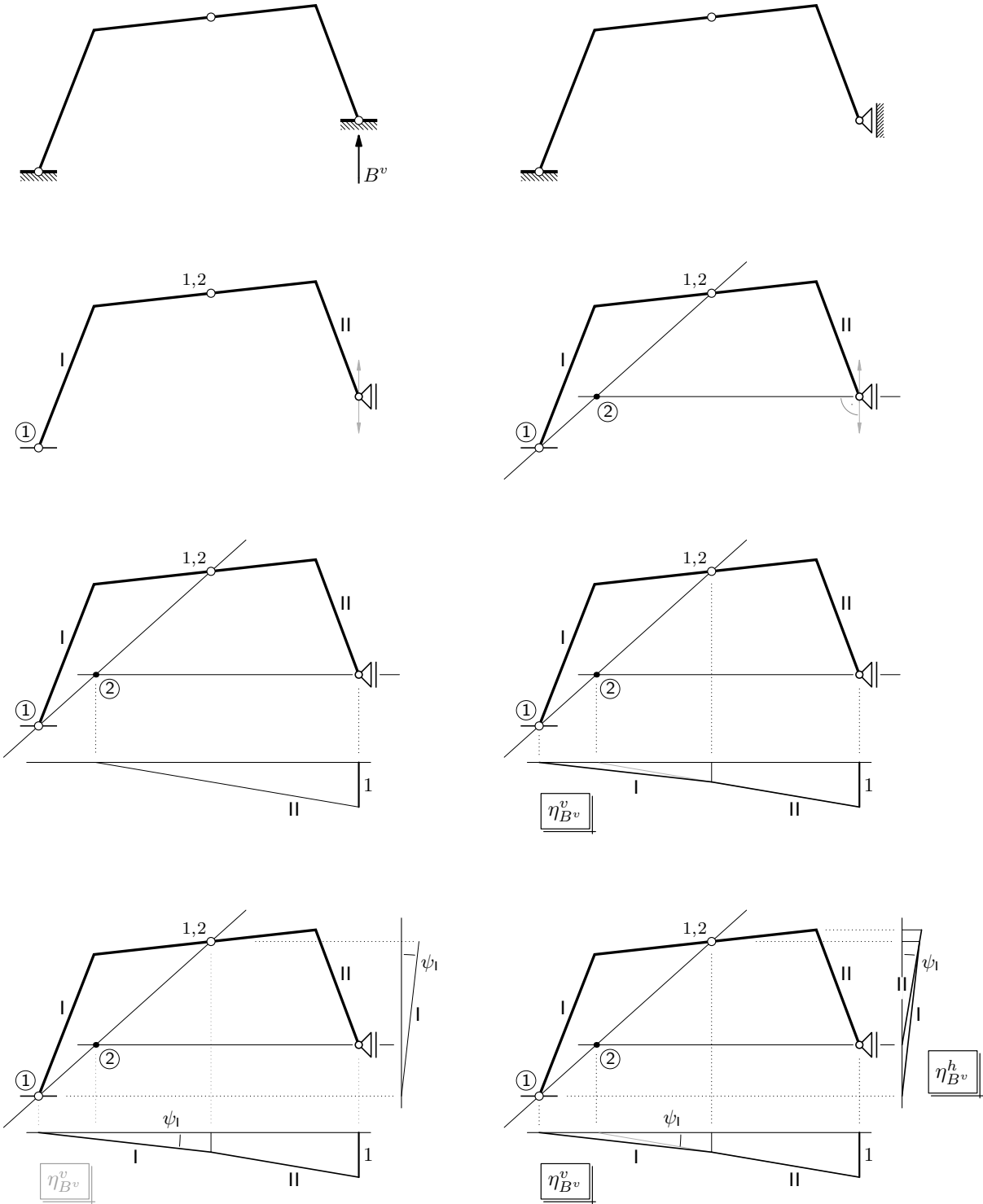

Nacrtajte UL za vertikalnu reakciju u lijevome ležaju!

Trozglobni okvir

UL za horizontalnu reakciju u desnome ležaju

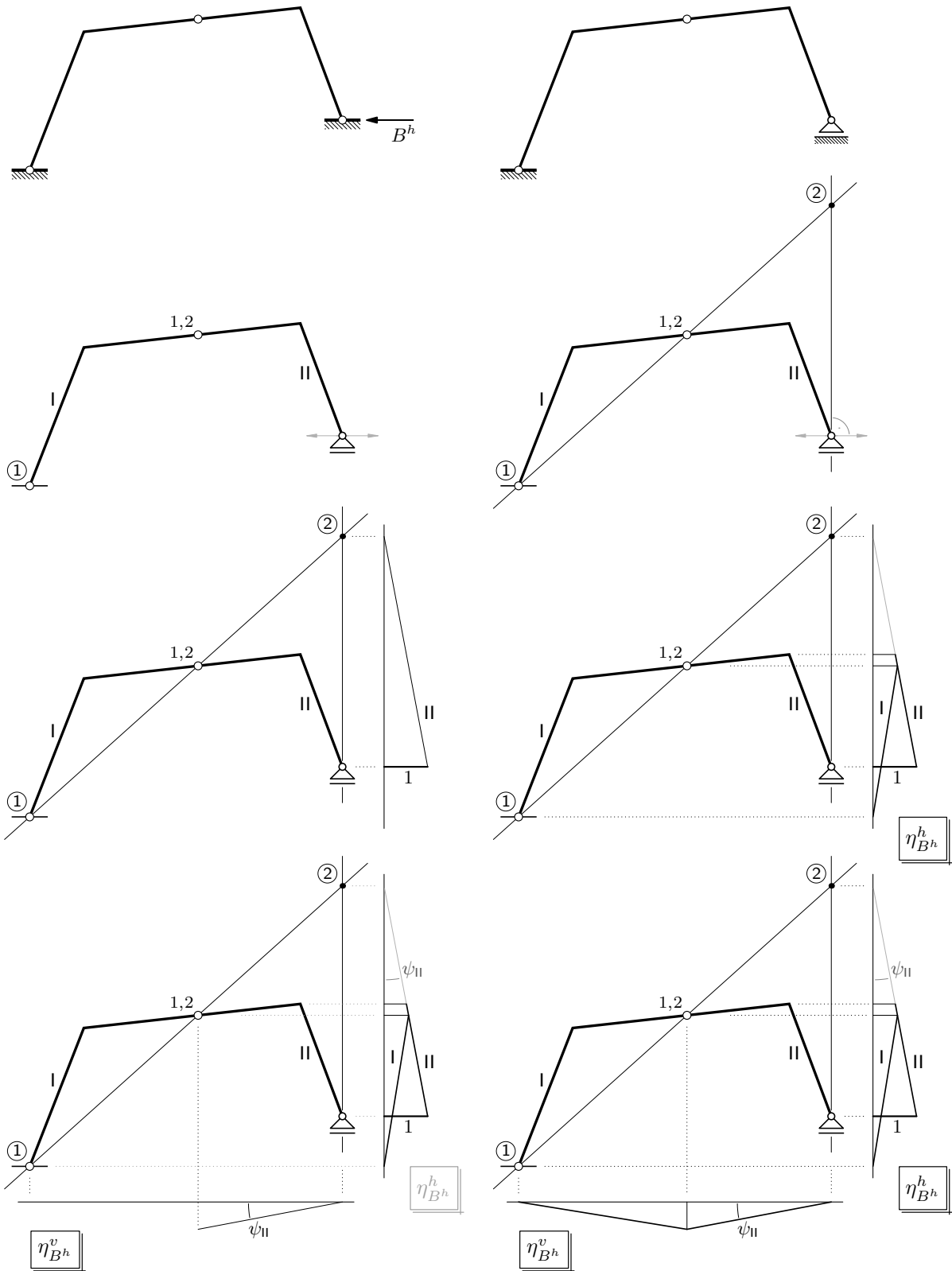

Nacrtajte UL za horizontalnu reakciju u lijevome ležaju!

Trozglobni okvir

UL za moment savijanja u presjeku $t-t$

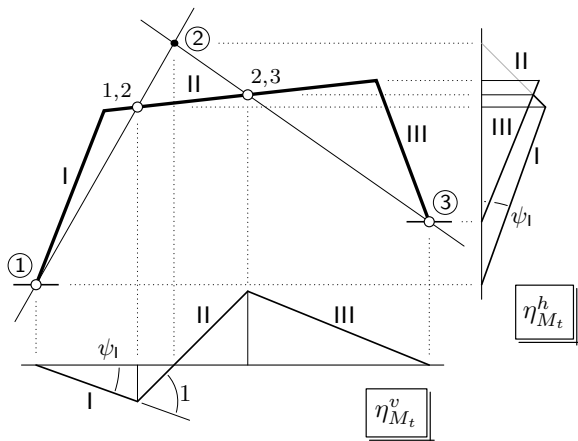
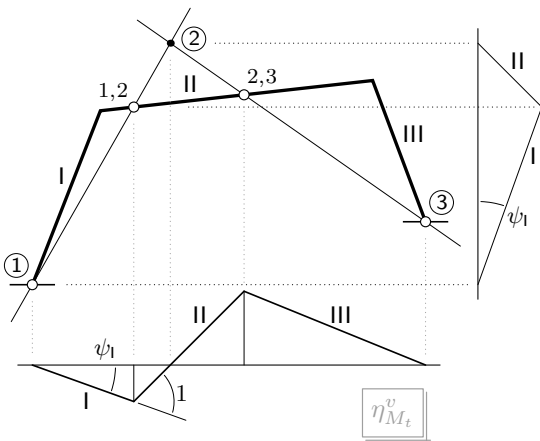
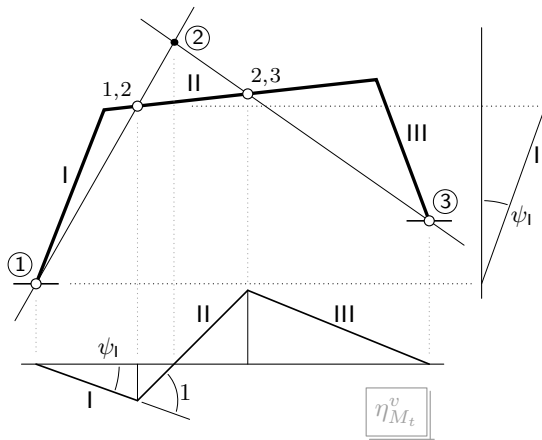
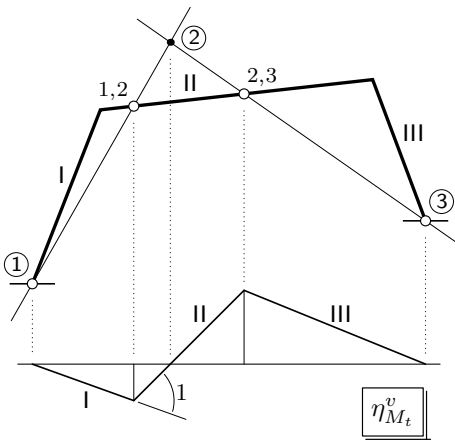
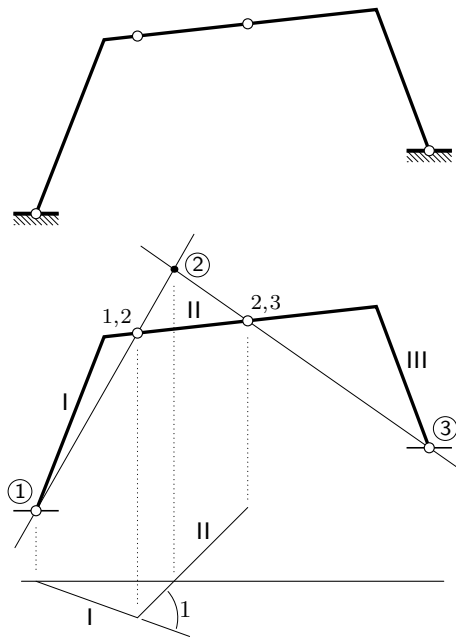
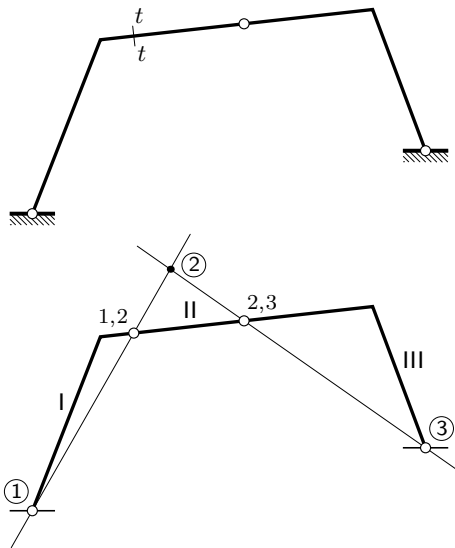

Nacrtajte UL za moment savijanja u presjeku desno od srednjega zgloba!

Trozglobni okvir

UL za poprečnu silu u presjeku $t-t$

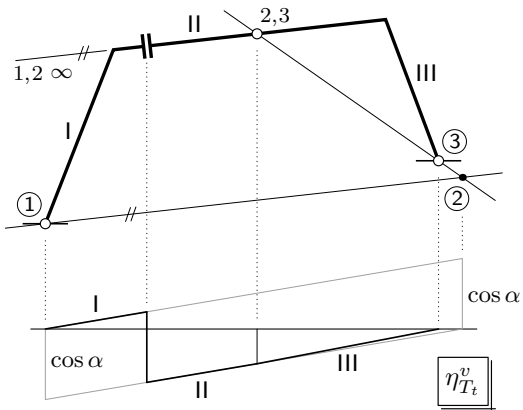
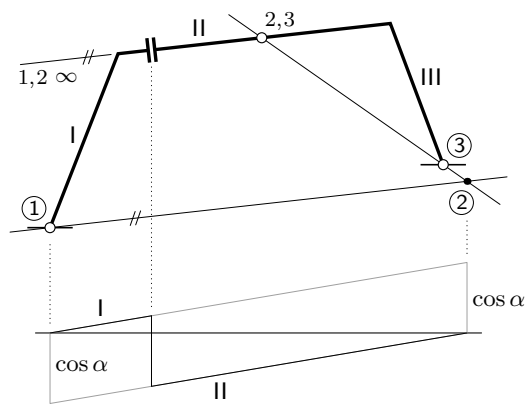
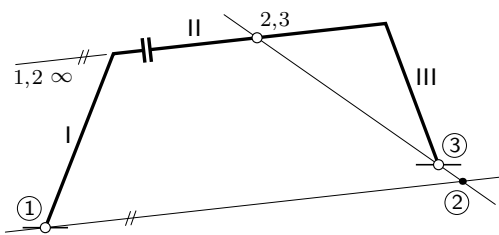
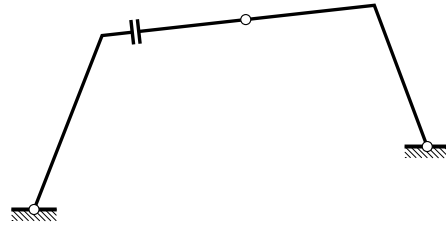
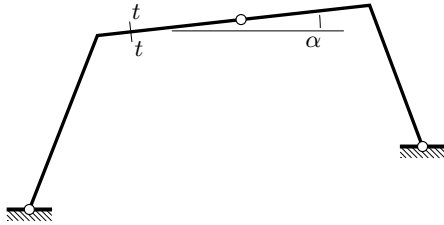

Zašto je u presjeku $t-t$ »skok« $\cos \alpha$?

Nacrtajte $\eta_{T_t}^h$!

Koliki je u njoj »skok« u presjeku $t-t$?

Trozglobni okvir

UL za uzdužnu silu u presjeku $t-t$

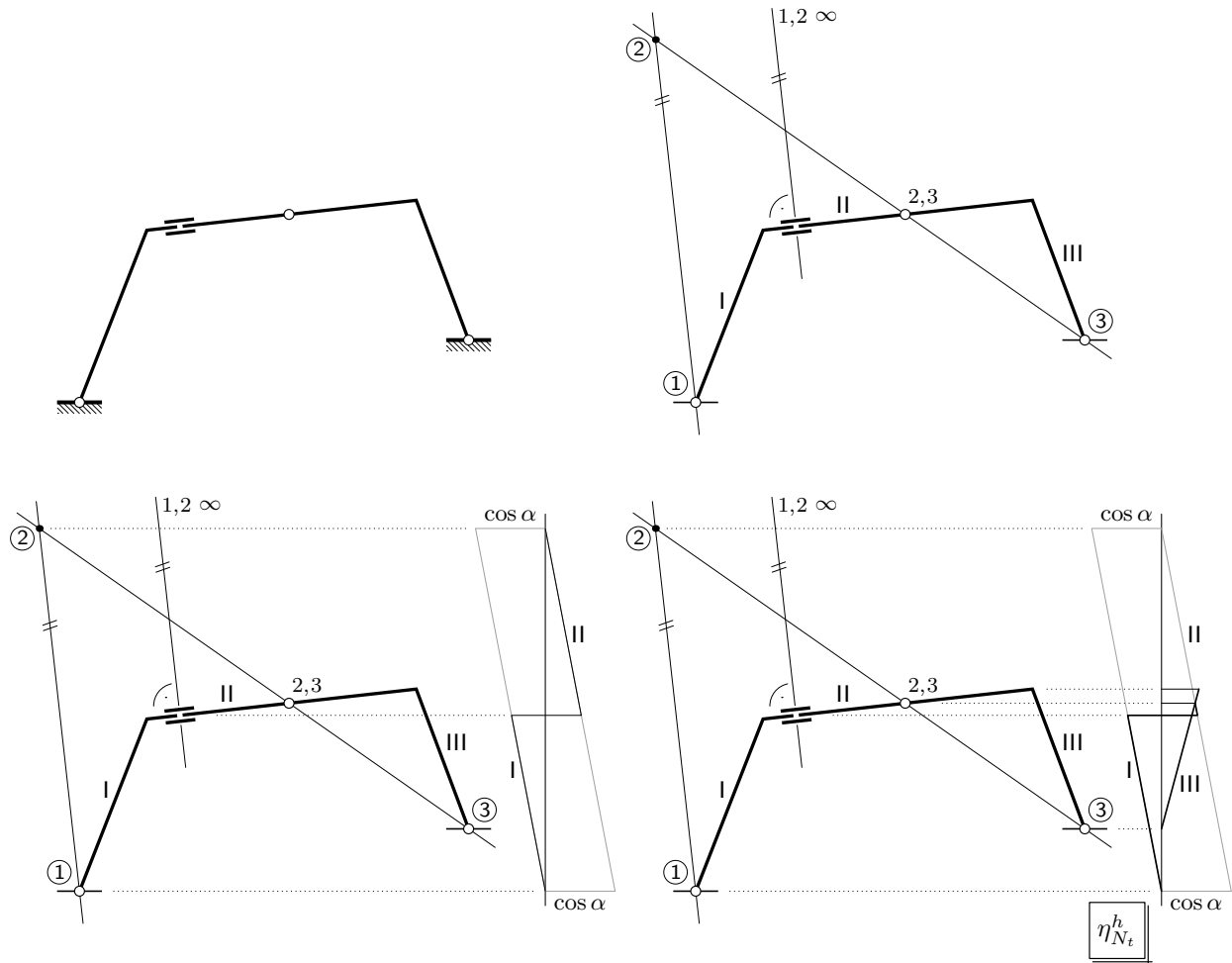

Zašto je u presjeku $t-t$ »skok« $\cos \alpha$?

Nacrtajte $\eta_{N_t}^v$!

Koliki je u njoj »skok« u presjeku $t-t$?

Trozglobni okvir sa zategom

UL za reakciju u desnome ležaju

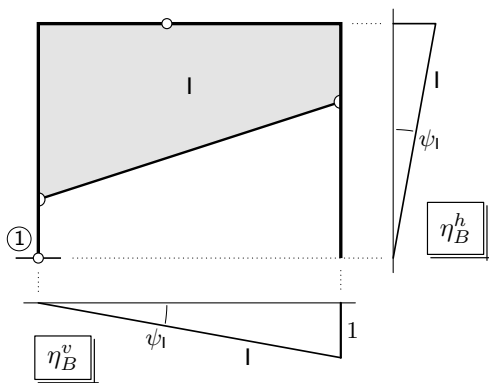
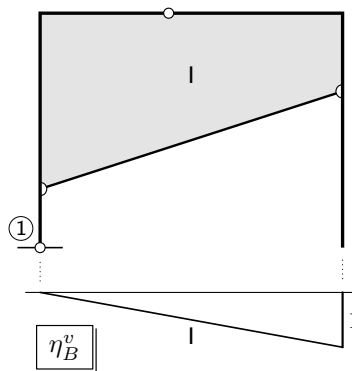
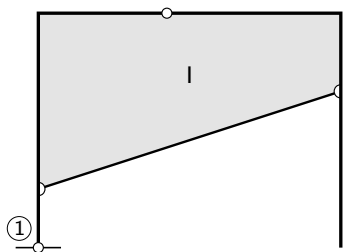
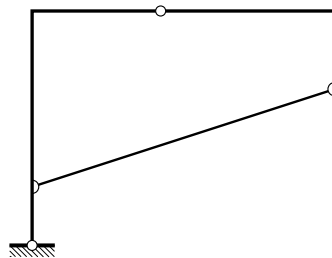
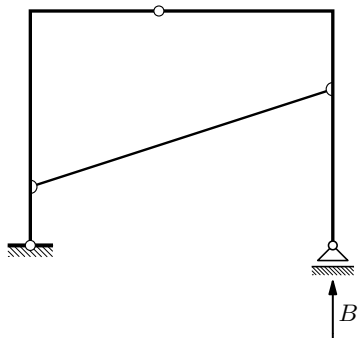

Trozglobni okvir sa zategom

UL za horizontalnu reakciju u lijevome ležaju

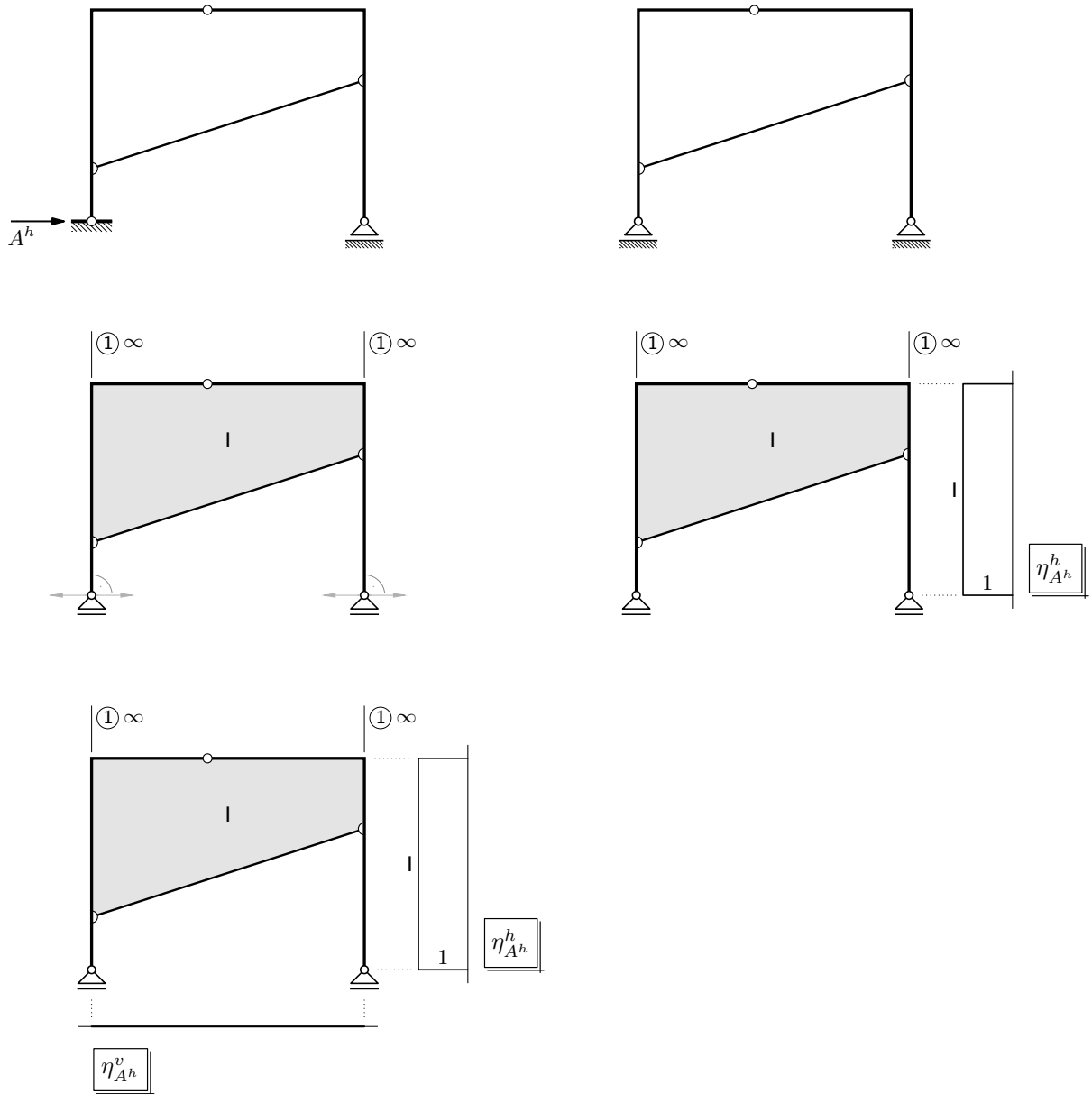

Nacrtajte UL za vertikalnu reakciju u lijevome ležaju!

Trozglobni okvir sa zategom

UL za moment savijanja u presjeku $t-t$

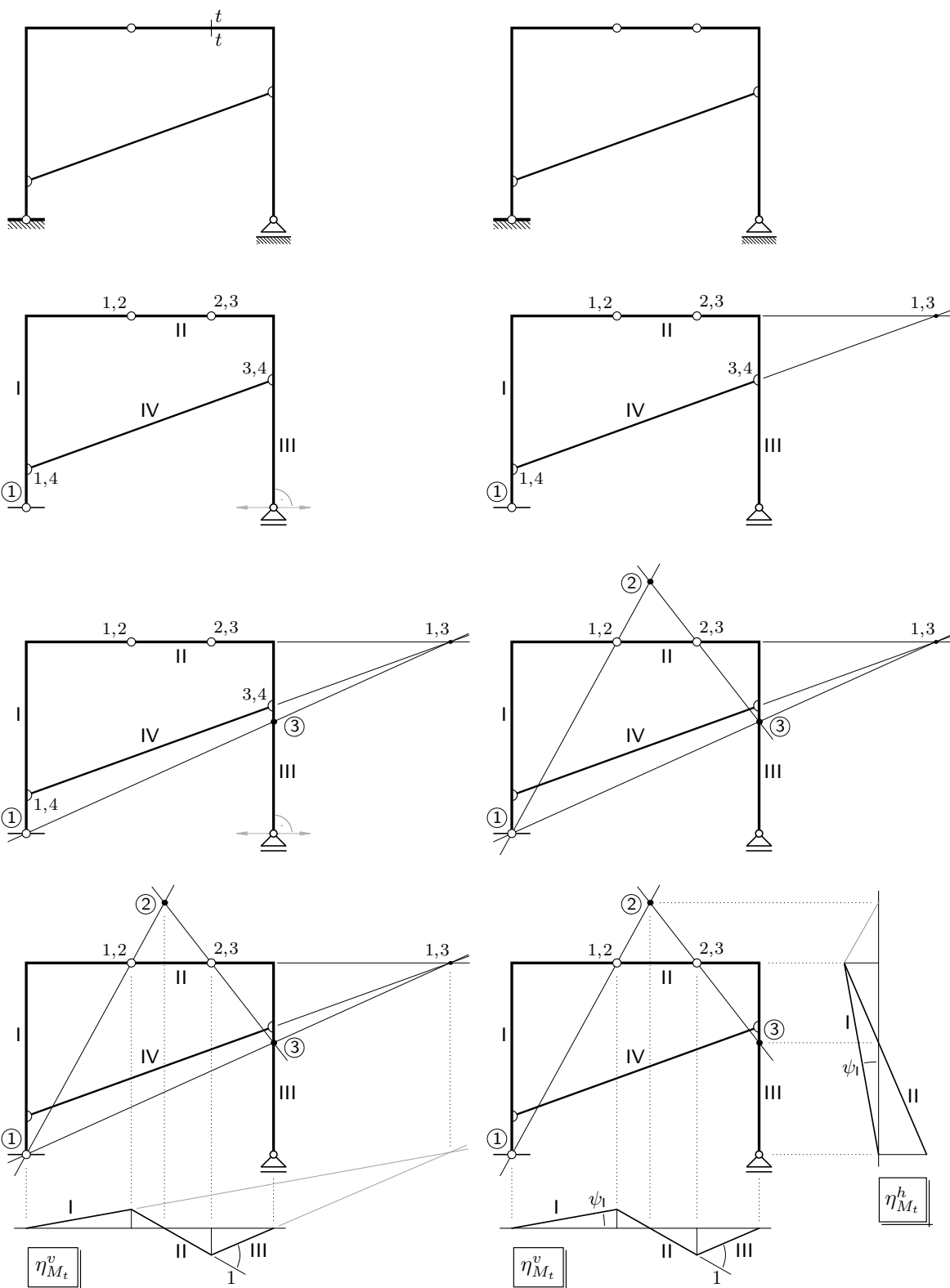

Nacrtajte UL za poprečnu i uzdužnu silu u presjeku $t-t$!